



DC Remotes



DR10 The DR10 is a telephone style DC Remote designed to provide control of a remotely located radio base station or repeater over an in house or leased metallic wire pair. The DR10 uses a simple dip switch to select the desired control current format and other features. No PC or programming cables required. Standard features include: receive and transmit audio compression, front panel transmit capability (on-hook), modular handset with soft touch PTT switch, line continuity sensor, parallel cross mute ability, standard modular line cord connections, line operated PTT indicator, two watts speaker output with volume control and off-hook CTCSS disable (monitor). See OPTIONS for a description of options and the price list for option compatibility when ordering.

DR20 The DR20 is a console style DC Remote with desk microphone designed to provide control of a remotely located base station or repeater over an in house or leased metallic wire pair. The DR20 uses a simple dip switch to select the desired control current format and other features. No PC or programming cables required. Standard features include: receive and transmit audio compression, split bar desk microphone, intercom, line continuity sensor, parallel cross mute ability, standard modular line cord connections, line operated PTT indicator, two watts speaker output with volume control and front panel monitor. See OPTIONS for a description of options and the price list for option compatibility when ordering.



DR30 The DR30 is a console style DC remote, with an internal electret microphone, designed to provide control of a remotely located base or repeater system over an in house or leased metallic wire pair. The DR30 uses a simple dip switch to select the desired control current format and other features. No PC or programming cables required. Standard features include: receive and transmit audio compression, front panel transmit button, intercom, line continuity sensor, parallel cross mute ability, standard modular line cord connections, line operated PTT indicator, two watts speaker output with volume control and front panel monitor. See OPTIONS for a description of options and the price list for option compatibility when ordering.

DR40 The DR40 is a console style DC remote, with a flexible goose-neck microphone, designed to provide control of a remotely located base or repeater system over an in house or leased metallic wire pair. The DR40 uses a simple dip switch to select the desired control current format and other features. No PC or programming cables required. Standard features include: receive and transmit audio compression, front panel transmit button, intercom, line continuity sensor, parallel cross mute ability, standard modular line cord connections, line operated PTT indicator, two watts speaker output with volume control and front panel monitor. See OPTIONS for a description of options and the price list for option compatibility when ordering.



DR Series Specifications

Power Requirements	120 VAC, 60Hz for wall pack operation
Audio Output to Speaker	2 Watts minimum (in compression) into 8 ohms with less than 3% distortion using supplied power pack.
Compression	Less than 3 dB increase in output with 30 dB increase beyond threshold of compression.
Line input	Adjustable, -20 dBm minimum.
Frequency Response	+/- 3dB from 300 to 3000 Hz. 1000 Hz reference.
Signal to noise ratio	50 dB below operating levels.
Line impedance	600 or 5000 ohms, dip switch selectable.
Line Output	Adjustable, +15 dBm maximum. Factory set at 0 dBm.
Dimensions	9" x 4" x 7" inches
Weight	DR10 - 3 lbs, DR20 - 4 lbs, DR30 - 3 lbs, DR40 - 4 lbs.
Connections	4 pin modular jack for handset. RJ11 for desk microphone and phone pair.

Options - Standard options shown - Call CPI for special options

- 2F** F1 / F2 push button. Control current format is dip switch selectable.
- WM** Wall mount kit. Includes snap on bracket for remote, wall mount plate and hardware.
- M** Push button monitor.
- DE** 12 key DTMF encoder.
- 4W** Four wire simplex operation. TX and RX audio on one pair, control current on the second pair.
- FD** Full duplex operation on four wires. TX audio and control current on one pair, RX audio on the second pair.
- BLK** Color is black instead of ash
- UE1** Multi-format encoder - multi format encoder/decoder available





DC Termination Panels

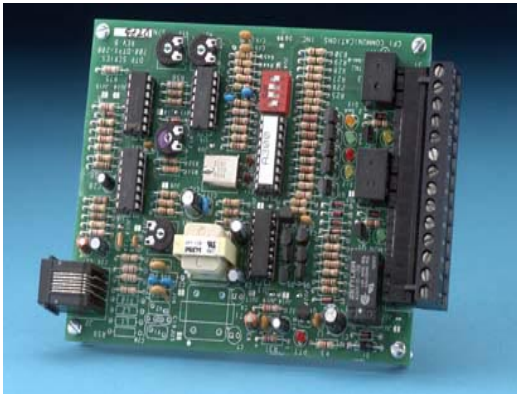

DTP Series The DTP Series DC termination panels provide a reliable, cost effective method of interfacing a DC remote control system to virtually any two-way radio. There are three basic models in the DTP series. The DTP1 provides TX and RX functions. The DTP2 provides TX, RX and Monitor functions. The DTP3 provides TX, RX, Monitor and F1/F2 functions. Standard features on all models include dip switch selection of control current format, amplified RX and TX audio levels, LED indication of current level detected, LED indication of current polarity, LED indication of active outputs, on board squelch circuit and the ability for local microphone audio to be passed back to the remotes. Metal enclosure, 4 wire and Full Duplex options are available.

MR100 The MR100 termination panels are a low cost, multi-featured DC termination panel that allows single channel remote control of Motorola's Radius, Maxtrac, CDM, 1225, GTX and other models. TX key provided with +6 mA current and monitor with -2.5 mA. The panels are housed in a rugged aluminium and steel enclosures and simply plug in to the microphone jack of the radio. Power connections are made on the back of the panel and a jack is provided on the front of the unit for a palm or desk microphone. The MR100 also provides adjustable amplified RX and TX audio and is PL and DPL compatible. A trunking version is available that allows status tones to be heard by the remote user while the remote is keyed.



JM100 The JM100 termination panels are a low cost, multi-featured DC termination panel that allows single channel remote control of the E.F. Johnson's Challenger and 8600 series radios. (Installation of the RX audio jumper required.) TX key provided with +11 to +15 mA current and monitor with +6 mA. The panels are housed in a rugged aluminium and steel enclosures and simply plug in to the microphone jack of the radio. Power connections are made on the back of the panel and a jack is provided on the front of the unit for a palm or desk microphone. The JM100 also provides adjustable amplified RX and TX audio. The **-TR option** is available that allows trunking status tones to be heard by the remote user while the remote is keyed.

YSU100 The YSU100 termination panels are a low cost, multi-featured DC termination panel that allows single channel remote control of the Yaesu's Vertex series radios with only minor radio modifications required. TX key provided with +12 mA current and monitor with +5.5 mA. The panels are housed in a rugged aluminium and steel enclosures and simply plug in to the microphone jack of the radio. Power connections are made on the back of the panel and a jack is provided on the front of the unit for a palm or desk microphone. The YSU100 also provides adjustable amplified RX and TX audio. Radio modification consists of adding a jumper to bring low level squelched audio to pin 2 of the microphone jack. Instructions are included.



DC Termination Panel Specifications

DTP Series

Power Requirements	+11 to +16 Vdc @ 35 mA idle.
Modulation Output	2 mVrms to 565 mVrms into 600 ohm load with 0 dBm input on phone line.
Line impedance	600 ohms.
Dimensions/Weight	5" x 4" x 1" inches - 1 lbs.
RX Input level	88 mVrms to 880 mVrms (Level required to provide 0 dBm to phone line.)
Connections	RJ11 jack for phone line. Screw terminals for radio connections.
Control Function outputs	PTT - Relay closure to ground or V+, jumper selectable. Monitor - Form "C" relay contacts. F1/F2 selection - Form "C" relay contacts.

100 SERIES Termination Panels

Power Requirements	+11 to +16 Vdc @ 16 mA. idle.
Modulation Output	0 to 360 mVrms, with 0dBm input on phone line.
Line impedance	600 ohms
Dimensions/Weight	5" x 5" x 1" inches - 2 lbs.
RX Input level	770 mVrms to 10 Vrms (Level required to provide 0 dBm to phone line.)
Connections	RJ11 jack for phone line and for radio connections.
Control Function outputs	Soild state.



Options

- TR** Allows trunking system status tones to be passed back to the while the termination panel is keyed. Not needed on DTP series panels.
- C** Metal enclosure for DTP series only.
- 4W** Four wire simplex operation. TX and RX audio on one pair, control current on the second pair.
- FD** Full duplex operation on four wires. TX audio and control current on one pair, RX audio on the second pair.





Tone Remotes



TR10 The TR10 is a telephone style Tone Remote designed to provide control of a remotely located radio base station or repeater over a voice grade wire pair. The TR series uses the E.I.A. standard sequential tone format which provides 2175 Hz. guard tone, 1950 Hz transmit key tone and 2175 Hz. hold tone. Standard features include: receive and transmit audio compression, 2175 Hz notch filter, on-hook and off-hook intercom capability, front panel transmit capability (on-hook), modular handset with soft touch PTT switch, standard modular line cord connections, LED transmit indicator, two watts speaker output with volume control and on-hook and off-hook CTCSS disable (monitor). See OPTIONS for a description of options and the price list for option compatibility when ordering.

TR20 The TR20 is a console style Tone Remote with desk microphone designed to provide control of a remotely located base station or repeater over a voice grade pair. The TR series uses the E.I.A. standard sequential tone format which provides 2175 Hz. guard tone, 1950 Hz transmit key tone and 2175 Hz. hold tone. Standard features include: receive and transmit audio compression, front panel and desk mic mounted PTT switch, LED transmit indicator, two watts speaker output with volume control, split bar desk microphone, intercom, modular line cord and desk mic connections and CTCSS disable (monitor). See OPTIONS for a description of options and the price list for option compatibility when ordering.



TR30 The TR30 is a console style tone remote, with an internal electret microphone, designed to provide control of a remotely located base or repeater system over a voice grade pair. The TR series uses the E.I.A. standard sequential tone format which provides 2175 Hz. guard tone, 1950 Hz transmit key tone and 2175 Hz. hold tone. Standard features include: receive and transmit audio compression, 2175 Hz notch filter, LED transmit indicator, two watts speaker output with volume control, intercom capability, monitor capability, and modular phone line connections that allow for easy installation and service. See OPTIONS for a description of options and the price list for option compatibility when ordering.

TR40 The TR40 is a console style tone remote, with a flexible goose-neck microphone, designed to provide control of a remotely located base or repeater system over a voice grade pair. The TR series uses the E.I.A. standard sequential tone format which provides 2175 Hz. guard tone, 1950 Hz transmit key tone and 2175 Hz. hold tone. Standard features include: receive and transmit audio compression, 2175 Hz notch filter, LED transmit indicator, two watts speaker output with volume control, intercom, monitor, and modular phone line connections that allow for easy installation and service. See OPTIONS for a description of options and the price list for option compatibility when ordering.



TR Series Specifications

Power Requirements	120 VAC, 60Hz for wall pack operation
Audio Output to Speaker	2 Watts minimum (in compression) into 8 ohms with less than 3% distortion using supplied power pack.
Compression	Less than 3 dB increase in output with 30 dB increase beyond threshold of compression.
Line input	Adjustable, -20 dBm minimum.
Frequency Response	+/- 3dB from 300 to 3000 Hz. Except at notch frequency. 1000 Hz reference.
Signal to noise ratio	50 dB
Line impedance	600 ohms / 5000 ohms
Line Output	Adjustable, +15 dBm maximum. Factory set at 0 dBm.
Control Tones	Security tone: 2175 Hz +/- 0.01% @ +10 dBm for 140 mS Function tones: 1950 Hz - 1050 Hz +/- 0.01% @ 0 dBm for 40 mS Monitor: 2050 Hz +/- 0.01% @ 0 dBm for 40 mS Transmit hold tone: 2175 Hz +/- 0.01% @ -20 dBm for duration of PTT
Dimensions	9" x 4" x 7" inches
Weight	TR10 - 3 lbs, TR20 - 4 lbs, TR30 - 3 lbs, TR40 - 4 lbs.
Connections	4 pin modular jack for handset. RJ11 for desk microphone and phone pair.

Options

- 2F** Push button selectable 1950 Hz for F1 and 1850 Hz for F2 frequency selection. LED indicators show selected frequency.
- WM** Wall mount kit. Includes snap on bracket for remote, wall mount plate and hardware.
- DE** 12 key DTMF encoder.
- 4W** Four wire simplex operation. Separate TX and RX audio pairs.
- FD** Full duplex operation on four wires.
- TR** Pseudo full duplex operation on two wires. Allows trunking status tones to be heard during remote PTT. Available on the TR10 only.

-BLK Black unit instead of ash





Multi Frequency Tone Remotes



TR10-4F The TR10-4F is a telephone style tone remote designed to provide control of up to 4 frequencies on a remotely located base station radio over a voice grade wire pair. The TR10-4F uses the E.I.A. standard sequential tone format which provides 2175 Hz guard tone, 1950-1650 Hz function tones, 2050 Hz monitor, and a 2175 Hz hold tone. Standard features on the unit include: receive

and transmit audio compression, 2175 Hz notch filter, on and off hook monitor, intercom, parallel status updating, PTI indication between remotes, crossmute, LED indicators and two watt audio output. The standard configurations for this unit are the 4 frequency TR10-4F and sixteen frequency **TR10-16F** (1950-450 Hz function tones) units. Either of these are available with a desk microphone or gooseneck microphone option. These remotes are ideal for use with the CPI **TTP216** tone termination panel or may be added to existing tone remote systems or base station radios that have a built in termination panel capable of multi-frequency control.



TR10-16F-BLK

TR10-16F-DM

TR10-4F-16F Specifications

Power Requirements	120 VAC, 60Hz for wall pack operation
Audio output to speaker	2 watts minimum (in compression) into 8 ohms with less than 3% distortion using supplied power pack
Compression	Less than 3 dB increase in output with 30 dB increase beyond threshold of compression.
Line Input	Adjustable, -20 dBm minimum
Frequency Response	+/- 3 dBm from 300 to 3000 Hz. except at notch frequency. 1000 Hz reference.
Signal to noise	50 dB
Line impedance	600 ohms / 5000 ohms
Line Output	Adjustable, +15 dBm maximum. Factory set at 0 dBm.
Control Tones	Security tone: 2175 Hz +/- 0.01% @ +10 dBm for 140 mS Function tones: 1950-450 Hz +/- 0.01% @ 0 dBm for 40 mS Monitor: 2050 Hz +/- 0.01% @ 0 dBm for 40 mS Transmit hold tone: 2175 Hz +/- 0.01% @ -20 dBm for duration of PTT
Dimensions/ Weight	9" x 4" x 7" / 4lbs.
Connections	4 pin modular for handset. RJ11 for desk microphone and phone pair

Option

Description

-4W	4 wire simplex operation - Seperate TX and RX pairs
-FD	Full duplex operation on 4 wires
-DE	12 key DTMF encoder
-UE1	12 key multi-format encoder
-WM	Wall mount kit - Includes snap on bracket and wall plate
-BLK	Unit color is black instead of ash
-DM	Desk microphone option - Deletes handset and adds desk microphone
-GM	Gooseneck microphone option - Deletes handset and adds gooseneck microphone





Tone Termination Panels

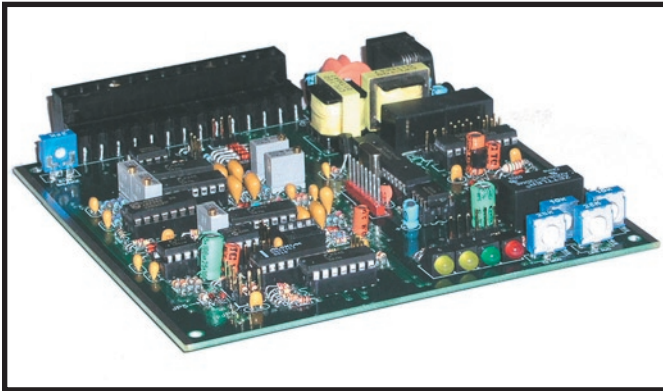

TTP1(N) The TTP1(N) is an EIA standard tone termination panel that can be interfaced to virtually any radio. Standard features of the TTP1(N) include: tone detection AGC (eliminates line in level adjustments), modular and screw terminal connections, jumper selectable 2 wire, 4 wire, or full duplex, and LED status indicators. The only available option for these units is a case option.

-C/TTP(N) This unit will interchange with the present TTP1 as the connector styles are identical. The TTP1 case option will not interchange as the TTP1(N) has additional circuitry resulting in a larger board size. The **TTP2(N)** is a two frequency version of the TTP1(N). These units are not field programmable. These units come standard with 1950-1850 Hz function tones, 2050 Hz monitor, and 2175 Hz guard and hold tones. Custom microcontrollers are available for different function tones and custom applications.

MR200(N) The MR200(N), MR202(N), and JM200(N) are radio specific modified TTP(N) units that interface through the microphone jack on certain radios. The MR series panel interfaces to most Motorola mobiles that use the 8 pin modular microphone. Maxtrac 100,300, Radius M10, 100, 120, M200, GM300, SM50, SM120, M1225, GTX, MCS2000, and CDM series radios. Two channel selection on the MR202 requires a radio jumper for channel selection. The JM200 interfaces to the Johnson Challenger and 8600 series radios. These units are enclosed and have the same features as the TTP(N) series.



TTP216 The TTP216 is an EIA standard 16 frequency user programmable tone termination panel. Users can program any one of the standard 1950-450 Hz function tones in any position or choose from one of the 14 standard pre-sets. Standard features of the TTP216 include: tone detection AGC (eliminates line in level adjustment), front panel microphone jack, modular and screw terminal connections, jumper selectable 2 wire, 4 wire, or full duplex. No programming software is required for this unit. This unit is ideal for radios that allow channel selection using BCD control.



Tone Panel Specifications

subject to change without notice

Input voltage	+12 to +13.8 VDC @ 150 mA (18mA idle)
Line impedance	600 ohms
Line output to phone line	+10 dBm max. preset to 0 dBm
Line output from phone line	-40 dBm to +10 dBm (function tone referenced)
RX input from radio	70 mVrms or greater
Notch filter	2175 down 50 dB from 1000 Hz reference
Dimensions TTP(N) series TTP(N)-C/MR series TTP216	5.3" wide x 1" high x 5" deep - unenclosed 5.5" wide x 1.5" high x 6.5" deep 5.5" wide x 1.5" high x 7.5" deep
Control Tones:	Guard tone = 2175Hz for 40 mS Function tones F1-F16 = 1950-450 Hz for 40 mS Monitor = 2050 Hz for 40 mS Hold tone = 2175 Hz for duration of PTT
Control function outputs	PTT and monitor selection are form "C" relay contacts. 1 amp @30 VDC F1/F2 are form "C" relay contact or open collector F3-F16 are open collector

Option

Description

-C/TTP(N)	Black, vinyl clad steel and aluminum enclosure for the TTP(N) series
Rack/TTP(N)	Single height 19" rack holds 3 TTP(N), MR, or TTP216 panels
-80 cable	Pre-made cable connects the TTP(N) series to the KCT-19 connector on -80 series mobiles
-90 cable	Pre-made cable connects the TTP(N) series to the DB25 on the -90 series
216-90	Pre-made cable connects the TTP216 series to the DB25 on the -90 series
-MOT/cable	Pre-made cable connects the TTP(N) series to the 16 pin accessory connector on most Motorola mobiles
216-MOT	Pre-made cable connects the TTP216 series to the 16 pin accessory connector on Motorola mobiles. GM300, M1225 4 channel, and CDM series





CPI Communications, Inc.
941 Hensley Lane Wylie, TX 75098

Telephone (972) 429-7165
Fax (972) 429-7165
(800) 869-9128

TONE TERMINATION PANELS



TTP1, TTP2

The TTP1 or TTP2 provide the interface between tone remotes using the industry standard tone format and any two-way radio base station allowing remote control of a two-way radio base station or repeater over a 600 ohm voice grade audio path. Interfacing the TTP1 or TTP2 termination panel is straight-forward. The audio input and output points are compatible with a wide range of radio microphone input and receiver audio output circuitry and a wide dynamic range allows for changes in phone line levels while providing reliable operation. A 2175 Hz notch filter removes the key tone from the modulation audio while a highly advanced sequential tone detection algorithm eliminates the possibility of falsing the termination panel into a transmit condition. The monitor circuit, for tone squelch disable, is selectable either for a timed output, or monitor until PTT. Two frequency selection is latching and will control transmit as well as receive for each channel.



MR 200 Series

The MR200 series termination panels are low cost multi-featured tone termination panels that allow single channel remote control of the Radius and Maxtrac type radios with no radio modification required. TX key is 1950 Hz and monitor function is 2050 Hz. The panels come housed in a rugged aluminum and vinyl clad steel enclosure. Features include: simple modular plug connections, remote and / or local operation, provides PTT and monitor functions, separately adjustable TX & RX audio amplification, and PL - DPL compatibility. Trunking ready, allows status tones to be heard by the remote user while the remote is keyed. The MR202 is a two frequency version that requires a jumper be added inside the radio.



JM 200

The JM200 is a tone termination panel designed for single channel or system use on the Johnson Challenger or 8600 series trunking radios. TX key is 1950 Hz and off-hook function is 2050 Hz. The panels come housed in a rugged aluminum and vinyl clad steel enclosure. Features include: simple modular plug connections, remote and / or local operation, provides PTT and off-hook functions, separately adjustable TX & RX audio amplification. Unit requires that receive audio in radio be jumpered to the radio microphone jack. Unit allows trunking status tones to pass back to properly equipped remotes enabling tones to be heard while remote is keyed.

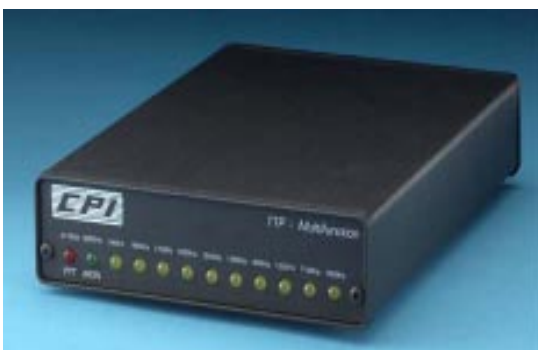

TTP - Multifunction, TTP-BCD

Four, six, eight and ten frequency versions of the TTP series tone termination panel. The panels are housed in a sturdy, steel and aluminium enclosure and provide LED indication of PTT, monitor and selected function tone. Frequency or function selection is accomplished by a 1 of 10 relay outputs that are jumper selectable for a latching or momentary operation. Available options include full duplex and four wire operation. A BCD version is available for radios equipped for BCD operation. (GM300, Kenwood-90)

Specifications

Subject to change without notice.

TTP1 - Single frequency with monitor, TTP2 - Two frequency with monitor

Size: 2.9" wide
.75" high
5.25" long

Connections:
modular to phone line
screw terminals for radio connections

General:

Input voltage: +12 to +13.8 Vdc @ 150 mA
(18 mA idle)
Line impedance: 600 ohms
Line output level: +7 dBm max. Preset to 0 dBm
Line input level: -5 dBm to +5 dBm (0 dBm typical)
Rx input level: 35 mVrms to 530 mVrms
Notch filter: 2175 down 50 dBm from 1000 Hz
reference

Control tones:

F1 transmit: 1950 Hz
F2 transmit: 1850 Hz
Monitor (tone squelch disable) :2050 Hz
Security tone: 2175 Hz
Tx hold tone: 2175 Hz
Time tolerance:
Security tone: 140 mS +/- 10%
Function tone: 40 mS +/- 10%

Control function outputs:

PTT: form "A" relay contacts
Frequency selection: form "C" relay contacts
Monitor: form "C" relay contacts

MR200 - Single frequency with monitor, MR202 - Two frequency with monitor

Size: 5.5" wide
1.5" height
6.5" depth

Connections:
Modular to radio (cable supplied)
a. MR Panel to radio.
b. Desk microphone to MR
panel
Modular or screw terminal to phone line.

General:

Same as TTP1 & TTP2

Control tones:

Same as TTP1 & TTP2

JM200 - Single frequency with off-hook function

Size: 5.5" wide
1.5" height
6.5" depth

Connections:
Modular to radio (cable supplied)
a. JM Panel to radio.
b. Desk microphone to JM panel
Modular or screw terminal to phone line.

General:

Same as TTP1 & TTP2

Control tones:

Same as TTP1 & TTP2

TTP - Multifunction

Size: 5.5" wide
1.5" height
7.5" depth

Connections:
modular to phone line
screw terminals for radio connections

General:

Same as TTP1 & TTP2

Control tones:

Specifications are the same as the TTP1 & TTP2
with the following possible additional tones.

Control function outputs:

PTT: form "A" relay contacts
Frequency selections: form "C" relay contacts
Monitor: form "C" relay contacts

F3: 1750 Hz. F4: 1650 Hz.
F5: 1550 Hz. F6: 1450 Hz.
F7: 1350 Hz. F8: 1250 Hz.
F9: 1150 Hz. F10: 1050 Hz.



Local Extensions



LE10 The LE10 is a telephone style local extension designed to provide remote control of a conventional or trunked radio base station or repeater at distances up to 1000 feet. The LE series is easily configured for use with virtually any radio and allows up to 25 units to be paralleled off a single radio. Advanced features of the LE series include the ability to hear transmissions made from parallel units as well as those made using the radio microphone. Standard features include: front panel transmit capability (on-hook), handset with soft touch PTT switch, standard modular coil cord connections, parallel LED transmit indicator, one watt amplified speaker with volume control, adjustable amplified modulation output and off-hook CTCSS disable (monitor). Options include wall mount bracket, two channel control, intercom and wall plug power pack.

LE20 The LE20 is a console style local extension with desk microphone designed to provide remote control of a conventional or trunked radio base station or repeater at distances up to 1000 feet. The LE series is easily configured for use with virtually any radio and allows up to 25 units to be paralleled off a single radio. Advanced features of the LE series include the ability to hear transmissions made from parallel units as well as those made using the radio microphone. Standard features include: front panel transmit capability, parallel LED transmit indicator, one watt amplified speaker with volume control, adjustable amplified modulation output, split bar desk microphone, intercom and push button CTCSS disable (monitor). Options include two channel control and wall plug power pack.



LE30 The LE30 is a console style local extension with internal electret microphone designed to provide remote control of a conventional or trunked radio base station or repeater at distances up to 1000 feet. The LE series is easily configured for use with virtually any radio and allows up to 25 units to be paralleled off a single radio. Advanced features of the LE series include the ability to hear transmissions made from parallel units as well as those made using the radio microphone. Standard features include: front panel transmit capability, LED transmit indicator, one watt amplified speaker with volume control, adjustable amplified modulation output, intercom and push button CTCSS disable (monitor). Options include wall mount bracket, two channel control and wall plug power pack.

LE40 The LE40 is a console style local extension with flexible goose-neck microphone designed to provide remote control of a conventional or trunked radio base station or repeater at distances up to 1000 feet. The LE series is easily configured for use with virtually any radio and allows up to 25 units to be paralleled off a single radio. Advanced features of the LE series include the ability to hear transmissions made from parallel units as well as those made using the radio microphone. Standard features include: front panel transmit capability, LED transmit indicator, one watt amplified speaker with volume control, adjustable amplified modulation output, intercom and push button CTCSS disable (monitor). Options include wall mount bracket, two channel control and wall plug power pack.



LE Series Specifications

Power Requirements	12 VDC to 16 VDC @ 35 mA idle, 175 mA maximum. Fused on circuit board.
Receive Audio Input Level	88 mVRMS to 880 mVRMS to provide full speaker output.
Audio Output to Speaker	1 Watt into 8 ohms with 13.8 VDC supply or using -WP option.
Transmit Audio Output	2 mVRMS to 565 mVRMS into 600 ohms.
Frequency Response	+/- 3dB from 300 to 3000 Hz. 1000 Hz reference.
Dimensions	9" x 4" x 7" inches
Weight	LE10 - 3 lbs, LE20 - 4 lbs, LE30 - 3 lbs, LE40 - 4 lbs. Option -WP - 1 lbs.
Connections	Screw terminal block for radio connections. 4 pin modular jack for handset. 6 pin for desk microphone.
PTT Output	Solid state to ground, can sink up to 2.5 amps. Keying to plus voltage available as an option.
Monitor Output	Normally closed or normally open relay contacts activated by hook switch or optional push button.
F1/F2 Select (Optional)	Latched or momentary pulsed N.O. or N.C. relay contacts.
Intercom(Optional)	Optional momentary push button activated circuit that allows audio transmissions between local extensions with out keying the radio. May be used on or off-hook.

Options

- M** Push button CTCSS disable. (Monitor)
- I** Push button intercom. May be used on or off-hook to communicate with other local extensions with out keying radio.
- 2F** Push button selectable momentary or latching relay output for frequency selection. LED indicators show selected channel.
- WP** Wall plug-in transformer power pack.
- WM** Wall mount kit. Includes snap on bracket for remote and wall mount plate and hardware.
- DE** 12 key DTMF encoder.

Installation Considerations

The LE series local extension will work with any radio system that will accept a 2 mVRMS to 565 mVRMS mic audio input level and provide an 88 mVRMS to 880 mVRMS receive audio output level.

If the radio is going to be used as a control point, the receive audio should be taken from a point after the squelch circuit that is unaffected by the radio's volume control.

If the radio is not going to be used as a control point, speaker output may be used by setting the radio's volume control for a level that falls into the above range.

The LE series requires 12 to 16 VDC @ 175 mA. This may be supplied from a central source at the radio site using a conductor in the hook-up cable or by using the -WP option. 18 to 22 gauge multi-conductor cabling is recommended with the number of conductors determined by the application and options installed.

A minimum configuration will use 6 conductors, a maximum will use 12.





DC to Tone Converter

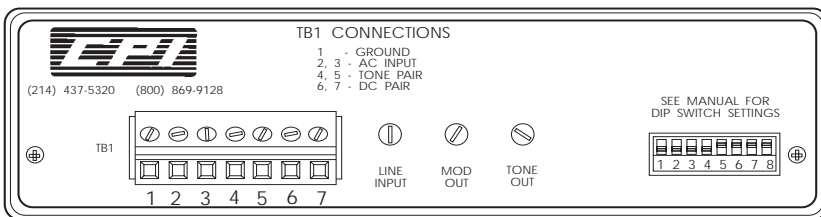
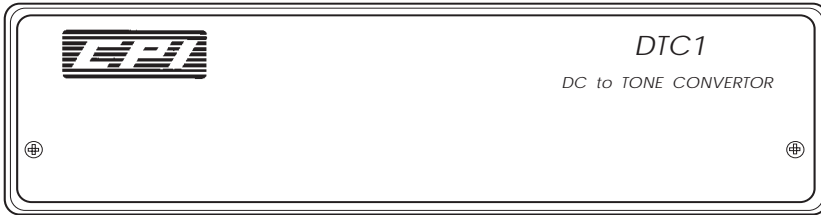

Description

The DTC1 DC to Tone converter converts your existing DC remote control system to the industry standard sequential tone format used by Motorola, GE, and other manufacturers. You can now, with the addition of the DTC1 and a CPI TTP series tone termination panel, or equivalent, continue to use your existing DC remotes after losing your hard-wire lines to a phone company conversion to voice grade circuits. A CPI TTP series tone termination panel will need to be installed at the transmitter.

The DTC1 provides adjustable audio amplification in both directions as well as a 2175 Hz. notch filter in the receive audio path to notch out the hold tone from any parallel tone remotes that may be on the system. The DTC1 is dip switch programmable to recognize one of eight DC current configurations, see chart below.

If DC Remote Provides				DTC1 will Provide			
PTT (F1)	PTT (F2)	MON (F1)	MON (F2)	GUARD TONE	FUNCTION TONE (F1)	FUNCTION TONE (F2)	MONITOR TONE
+/- 15 mA				2175 Hz	1950 Hz		
+/- 6 mA				2175 Hz	1950 Hz		
+/- 15 mA		+/- 6 mA		2175 Hz	1950 Hz		2050 Hz
+ 15 mA		- 6 mA		2175 Hz	1950 Hz		2050 Hz
+/- 6 mA		+/- 2.5 mA		2175 Hz	1950 Hz		2050 Hz
+ 6 mA		- 2.5 mA		2175 Hz	1950 Hz		2050 Hz
+ 6 mA	+ 15 mA	- 2.5 mA	- 2.5 mA	2175 Hz	1950 Hz	1850 Hz	2050 Hz
+ 15 mA	- 15 mA	+ 6 mA	- 6 mA	2175 Hz	1950 Hz	1850 Hz	2050 Hz

DTC Series Specifications

Power Requirements	12VAC @ 300ma. Wall pack provided. Unit may also be powered directly from a 12 VDC source.
Controls	Line Input, Mod Out, Tone Out
Line input/output impedance	600 ohms or 5000 ohms bridged. Balanced input.
Control Tones	Guard tone=2175 Hz, Function tones=1950 Hz, 1850 Hz or 2050 Hz, Hold tone=2175 Hz for duration of PTT
Tone Duration	Guard tone = 140 ms \pm 1%; Function tones = 40 ms \pm 1%
Line output level	+10 dBm maximum into 600 ohm line, adjustable.
Notch Filter	Attenuates 2175 Hz tone from parallel remotes by 50 dB.
DC Control Input Levels	“15 mA” = 9.5 - 18 mA; “6 mA” = 4.5 - 9 mA; “2.5” = 1.5 - 4 mA
Dimensions, Weight	5.5" x 5.5" x 1.5", 3lbs.

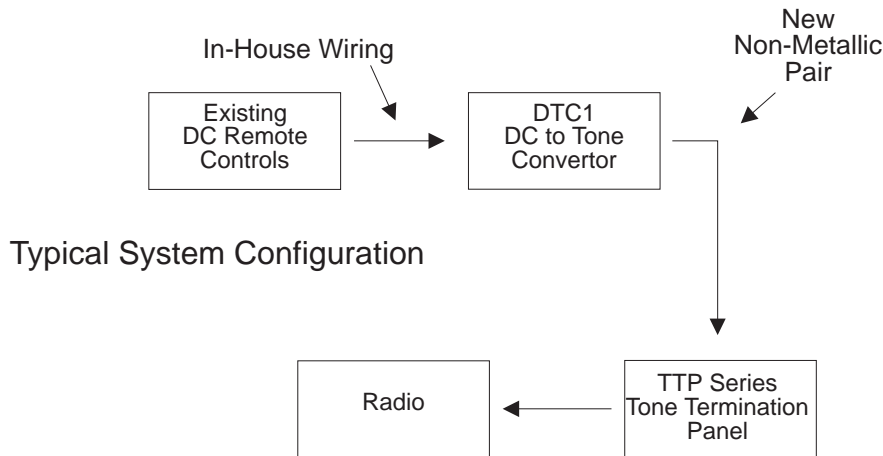



Multi-Channel Products for Motorola's® Radius® & Maxtrac®



MCR210 The MCR210 is a telephone style remote control unit designed for use with the Radius 200 series, GM300, SM120, M1225, M1225LS and Motorola's Maxtrac 300 conventional radios. The remote provides LED displays for channel indication, channel up and down buttons, PTT indicator, on-hook PTT capability, monitor button and indicator, intercom button, scan button and indicator and speaker volume control. The MCR210 allows incoming calls to be received through the speaker in the remote and transferred to the earpiece when the handset is removed from the cradle. Transmissions made from a remote are heard on all parallel remotes. The MCR210 allows for intercom capability between parallel remotes. The channel display and indicators on all remotes mirror that of the radio.

MCR220 The MCR220 is a console style remote control unit, with desk microphone designed for use with the Radius 200 series, GM300, SM120, M1225, M1225LS and Motorola's Maxtrac 300 conventional radios. The remote provides LED displays for channel indication, channel up and down buttons, PTT indicator, on-hook PTT capability, monitor button and indicator, intercom button, scan button and indicator and speaker volume control. The MCR220 allows incoming calls to be received through the speaker in the remote. Transmissions made from a remote are heard on all parallel remotes. The MCR220 allows for intercom capability between parallel remotes. The channel display and indicators on all remotes mirror that of the radio.



MCR250 The MCR250 is a single height, 19" rack mount remote control unit designed for use with the Radius 200 series, GM300, SM120, M1225, M1225LS and Motorola's Maxtrac 300 conventional radios. The remote provides LED displays for channel indication, channel up and down buttons, PTT button and indicator, monitor button and indicator, intercom button, scan button and indicator, panel mounted electret microphone and speaker volume control. The MCR250 allows incoming calls to be received through the speaker in the remote. Transmissions made from a remote are heard on all parallel. The MCR250 allows for intercom capability between parallel remotes. The channel display and indicators on all remotes mirror that of the radio.

MCR210 alpha The *MCR210 alpha* is an enhanced version of the MCR210 remote control unit designed for use with the Radius 200 series, GM300, SM120, M1225, M1225LS and Motorola's Maxtrac 300 conventional radios. The most noticeable enhancement is the addition of a Liquid Crystal Display. The LCD displays the channel number and up to ten characters of a user programmable channel name. Also added is the SELECT button, which allows more control of the radios scan functions. The new PRIVACY button, when pressed, will mute all parallel remotes allowing a private conversation between you and the mobile unit. Older MCR210s may require a software upgrade to allow muting to take place. The speaker audio output has also been increased to two watts. Please note: radio functions that require an extended push and hold of a front panel button are not supported from the remote.



MCP200 series Termination Panels The are five models of MCP200 series termination panels. The MCP200 - for use with Maxtrac 300 series and Radius M200 series radios; the MCP200G - for use with Radius GM300 radios; the MCP200M - for use with Radius M1225 20 ch; the MCP200MLS - for use with Radius M1225LS radios; and the MCP200S - for use with Radius SM120 radios. All models consists of two parts. The first is a small adaptor board that is installed in the radio. Installation is plug-in with no wire cutting, crimping or soldering involved. The second is the termination panel, housed in a rugged metal enclosure. The system may use any two wire, full duplex voice grade circuit between the radio and remote sites. Four wire interface optional.



MCR / MCP200 Series Specifications

MCR210, MCR220, MCR250 and MCR210 alpha

Power Requirements	12 Vdc at 300 mA (alpha = 500 mA)
Indicators	Channel, PTT, Scan and Monitor. (Privacy on alpha)
Controls	Channel up & down, PTT, Scan, Monitor, Intercom and volume control. (Privacy and Select on alpha)
Line input level	-10 dBm to 0 dBm (-20 dBm to +10 dBm on alpha)
Line output level	-10 dBm to +8 dBm adj. (-20 dBm to +10 dBm on alpha)
Line impedance	200 K ohms on-hook / idle, 600 ohms off-hook / active
Receive compression	Less than 3 dBm change in output for 30 dBm change in input above threshold.
Speaker output	1.2 watts at full compression (2 watts on alpha), speaker mutes when handset off-hook.
Intercom	Front panel microphone and intercom switch or with handset & intercom switch.
Max. no. of parallel remote sites	50
Connections	Modular jack for phone line and desk mic, 4 position modular jack for handset. MCR250 has terminal strip connections for power, ground and an external handset.
Dimensions, Weight	5.5" x 9" x 10", 5 lbs

MCP200 series - Termination Panels

Power requirements	13.6 Vdc, limited to 100 mA. Power taken from radio microphone jack.
TX Control	Adjusts audio level to the radio microphone input.
RX Control	Adjusts audio level to phone line. Adjustable from -20 dBm to +10 dBm.
Intercom/Test button	Used for test mode on power up, then for intercom.
Line balance	Used to match the MCP200 to phone line.
Phone line impedance	600 ohms
Connections to phone line	Two wires via modular jack. Four wire interface optional.
Connections to radio	Supplied cable plugs into radio mic jack and "Radio" jack on MCP200 or MCP200G. MCP200M, MCP200MLS and MCP200S - Supplied cable plugs into radio accessory connector and "Radio" jack on termination panel.
Connection to microphone	Modular jack on front of MCP200 or MCP200G, allows use of Motorola palm or desk mic. This feature not available on MCP200M, MCP200MLS or MCP200S <i>Radio is remote operation only.</i>
Dimensions & Weight	1.6" x 5.5" x 5.5", 1.5 lbs.





Multi-Channel Products for Kenwood® Conventional Radios



MCR411A The MCR411A is a telephone style remote control unit designed for use with Kenwood's -90 series conventional radios. The remote has an LCD displays for group and channel indication and 9 character alpha channel alias. The remote provides group and channel up and down buttons, PTT indicator, on-hook PTT capability, monitor button and indicator, intercom button, scan button and indicator, privacy feature, and speaker volume control. The MCR411A allows incoming calls to be received through the speaker in the remote and transferred to the earpiece when the handset is removed from the cradle. Transmissions made from a remote are heard on all parallel remotes. The MCR411A allows for intercom capability between parallel remotes. The channel display and indicators on all remotes mirror that all other MCR411A remotes on the system. When connected to the radio, the radio becomes dedicated to remote operation. You must use the MCP401 termination panel with this system.

MCP401 The MCP401 termination panel provides the interface between the -90 series radios and the MCR411A remotes. Installation of the termination panel is plug-in with no wire cutting, crimping or soldering involved. It is housed in a rugged metal enclosure that mounts securely to the top of the radio and connects to the radio via the DB25 accessory connector. The system may use any two wire or full duplex voice grade circuit between the radio and remote sites. Four wire/ full duplex is optional on this termination panel. When the termination panel is connected to the radio the radio becomes dedicated to remote operation. *** When controlling the -90 series using the CAD port, the display on the radio reads "COMPUTER" and all buttons on the radio are disabled.



TSP412A The TSP412A is a telephone style remote control unit designed for use with Kenwood's -80 series conventional/trunking radios. The remote has an LCD displays for system and group indication and 9 character alpha channel alias. The remote provides system and group up and down buttons, PTT indicator, on-hook PTT capability, monitor button and indicator, intercom button, scan button and indicator, privacy feature, and speaker volume control. The TSP412A allows incoming calls to be received through the speaker in the remote and transferred to the earpiece when the handset is removed from the cradle. Transmissions made from a remote are heard on all parallel remotes. The TSP412A allows for intercom capability between parallel remotes. The system/group display and indicators on all remotes mirror that all other TSP412A remotes on the system. When connected to the radio, the radio becomes dedicated to remote operation. You must use the TSP402 termination panel with this system.

TSP402 The TSP402 termination panel provides the interface between the -80 series radios and the TSP412A remotes. Installation of the termination panel is plug-in with no wire cutting, crimping or soldering involved. It is housed in a rugged metal enclosure that mounts securely to the top of the radio and connects to the radio via the Kenwood KCT19 accessory connector. The system may use any two wire or full duplex voice grade circuit between the radio and remote sites. Four wire/ full duplex is optional on this termination panel. When the termination panel is connected to the radio the radio becomes dedicated to remote operation. ***When controlling the -80 series using the CAD port all buttons on the radio are disabled.



MCR / TSR Series Specifications

MCR411, TSP412 alpha

Power Requirements	12 Vdc at 300 mA (alpha = 500 mA)
Indicators	Channel/Group, System/Group, PTT, Scan and Monitor, Privacy
Controls	Channel, System, Group up & down, PTT, Scan, Monitor, Intercom, Privacy, and volume control.
Line input level	-20 dBm to +10 dBm
Line output level	-20 dBm to +10 dBm
Line impedance	200 K ohms on-hook / idle, 600 ohms off-hook / active
Receive compression	Less than 3 dBm change in output for 30 dBm change in input above thresh-hold.
Speaker output	2 watts (speaker mutes when hand-set off-hook)
Intercom	Front panel microphone and intercom switch or handset & intercom switch
Max. no. of parallel remotes	50
Connections	Modular jack for phone line and desk mic, 4 position modular jack for handset.
Dimensions, Weight	5.5" x 9" x 10", 5 lbs

MCP401/ TSP402 - Termination Panel

Power requirements	13.6 Vdc, limited to 100 mA. Power taken from radio accessory jack.
TX Control	Adjusts audio level to the radio microphone input.
RX Control	Adjusts audio level to phone line. Adjustable from -20 dBm to +10 dBm.
Intercom/Test button	Used for test mode on power up, then for intercom.
Line balance	Used to match the MCP401/TSP402 to phone line.
Phone line impedance	600 ohms
Connections to phone line	Two wires via modular jack. Four wire interface optional.
Connections to radio	Supplied cable plugs into "Radio" DB25 or KCT19 connector
Dimensions & Weight	1.6" x 5.5" x 5.5", 1.5 lbs.





Multi-Channel Products for Kenwood® Conventional Radios



MCR410 The MCR410 is a telephone style remote control unit designed for use with Kenwood's TK630, TK730 and TK830 conventional radios. The remote provides LED displays for channel indication, channel up and down buttons, PTT indicator, on-hook PTT capability, monitor button and indicator, intercom button, scan button and indicator and speaker volume control. The MCR410 allows incoming calls, as well as transmissions made using the radio microphone, to be received through the speaker in the remote and transferred to the earpiece when the handset is removed from the cradle. Transmissions made from a remote are heard on all parallel remotes as well as over the radio speaker. The MCR410 allows for intercom capability between parallel remotes and between remotes and radio. The channel display and indicators on all remotes mirror that of the radio.

MCR420 The MCR420 is a console style remote control unit, with desk microphone designed for use with Kenwood's TK630, TK730 and TK830 conventional radios. The remote provides LED displays for channel indication, channel up and down buttons, PTT indicator, on-hook PTT capability, monitor button and indicator, intercom button, scan button and indicator and speaker volume control. The MCR420 allows incoming calls, as well as transmissions made using the radio microphone, to be received through the speaker in the remote. Transmissions made from a remote are heard on all parallel remotes as well as over the radio speaker. The MCR420 allows for intercom capability between parallel remotes and between the remotes and radio. The channel display and indicators on all remotes mirror that of the radio.



MCR410 alpha The *MCR410 alpha* is an enhanced version of the MCR410 remote. The most noticeable enhancement is the Liquid Crystal Display. The LCD will display the channel number and up to ten characters of a user programmable channel name such as "DISPATCH" or "REPEATER 1". We have also added a PRIVACY button. When pressed, this feature will mute all parallel remotes allowing a private conversation between you and the mobile unit. The speaker audio output has also been increased to two watts. Please note: radio functions that require an extended push and hold of a front panel button are not supported from the remote. Four wire interface optional.

MCP400 The MCP400 termination panel provides the interface between the TK630, TK730 and TK830 radios and the above remotes. The termination panel consists of two parts. The first is a small adaptor board that is installed in the radio. Installation is plug-in with no wire cutting, crimping or soldering involved. The second is the termination panel. It is housed in a rugged metal enclosure that mounts securely to the top of the radio and connects to it via the Accessory connector. A desk or hand microphone may then be plugged into the jack provided on the MCP400, the mic jack on the radio is not used. The system may use any two wire, full duplex voice grade circuit between the radio and remote sites. Four wire interface optional.



MCR / MCP400 Series Specifications

MCR410, MCR420 and MCR410 alpha

Power Requirements	12 Vdc at 300 mA (alpha = 500 mA)
Indicators	Channel, PTT, Scan and Monitor. (Privacy on alpha)
Controls	Channel up & down, PTT, Scan, Monitor, Intercom and volume control. (Privacy and Select on alpha)
Line input level	-10 dBm to 0 dBm (-20 dBm to +10 dBm on alpha)
Line output level	-10 dBm to +8 dBm adj. (-20 dBm to +10 dBm on alpha)
Line impedance	200 K ohms on-hook / idle, 600 ohms off-hook / active
Receive compression	Less than 3 dBm change in output for 30 dBm change in input above threshold.
Speaker output	1.2 watts at full compression (2 watts on alpha), speaker mutes when handset off-hook.
Intercom	Front panel microphone and intercom switch or with handset & intercom switch.
Max. no. of parallel remote	s 50
Connections	Modular jack for phone line and desk mic, 4 position modular jack for handset.
Dimensions, Weight	5.5" x 9" x 10", 5 lbs

MCP400 - Termination Panel

Power requirements	13.6 Vdc, limited to 100 mA. Power taken from radio microphone jack.
TX Control	Adjusts audio level to the radio microphone input.
RX Control	Adjusts audio level to phone line. Adjustable from -20 dBm to +10 dBm.
Intercom/ Test button	Used for test mode on power up, then for intercom.
Line balance	Used to match the MCP400 to phone line.
Phone line impedance	600 ohms
Connection to phone line	Two wires via modular jack. Four wire interface optional.
Connections to radio	Supplied cable plugs into "Radio" jack on MCP400 and radio accessory connector.
Connection to microphone	Modular jack on front of MCP400, allows use of Kenwood palm or desk mic.
Dimensions & Weight	1.6" x 5.5" x 5.5", 1.5 lbs.

These products are intended for use on Kenwood TK630, TK730 and TK830 models using the basic control head only.





Multi-Channel Products for Midland's® Syntech® XTR Radio



MCR310 The MCR310 is a telephone style remote control unit designed for use with Midland's Syntech XTR conventional underdash radios. The remote provides a handset with PTT, LED displays for channel indication, channel up and down buttons, PTT indicator, on-hook PTT capability, monitor button and indicator, P-scan button and indicator, N-scan button and indicator, A/D button and indicator, intercom button and speaker volume control. The MCR310 allows incoming calls, as well as transmissions made using the radio microphone, to be received through the speaker in the remote and transferred to the earpiece when the handset is removed from the cradle. Transmissions made from a remote are heard on all parallel remotes as well as over the radio speaker. The remote allows for intercom capability between parallel remotes and between remotes and radio. The channel display and indicators on all remotes mirror that of the radio. The remotes will work with both the 22 and 99 channel versions of the radio but may not be compatible with all combinations of options.

MCR320 The MCR320 is a console style remote designed for use with Midland's Syntech XTR conventional underdash radios. The remote provides a desk microphone, LED displays for channel indication, channel up and down buttons, PTT indicator, monitor button and indicator, P-scan button and indicator, N-scan button and indicator, A/D button and indicator, intercom button and speaker volume control. The MCR320 allows incoming calls, as well as transmissions made using the radio microphone, to be received through the speaker in the remote. Transmissions made from a remote are heard on all parallel remotes as well as over the radio speaker. The remote allows for intercom capability between parallel remotes and between remotes and radio. The channel display and indicators on all remotes mirror that of the radio. The remote will work with both the 22 and 99 channel versions of the radio but may not be compatible with all combinations of options.



MCP300 The MCP300 is the termination panel for use with the above remotes. The termination panel consists of two parts. The first is a small adaptor board that is installed in the radio. Installation is plug-in with no wire cutting, crimping or soldering involved. The second is the termination panel. It is housed in a rugged metal enclosure that mounts securely to the top of the radio and connects to it via the power accessory plug. A desk or hand microphone may then be plugged into one of the jacks provided on the MCP300. The jack on the radio will not be used. The system may use any two wire, full duplex voice grade circuit between the radio and remote sites. The termination panel will work with both the 22 and 99 channel versions of the underdash radios and the conventional base stations but may not be compatible with all combinations of options.



MCR / MCP300 Series Specifications

MCR310 and MCR320

Power Requirement s 12 Vdc at 300 mA
Indicator s Channel, PTT, and Monitor.
Control s Channel up/ down, PTT, P-Scan, N-Scan, Monitor, Intercom, and volume control.
Line input level -10 dBm to 0 dBm
Line output level -10 dBm to +8 dBm adj.
Line impedanc e 200 K ohms on-hook / idle, 600 ohms off-hook / active.
Receive compressio n Less than 3 dBm change in output for 30 dBm change in input above threshold. e
Speake r output 1.2 watts at full compression.
Interco m Front panel microphone and intercom switch or handset intercom switch.
Max. no. of parallel remote s 50
Connection s 6 position modular jack for phone line and desk mic. 4 position jack for handset.
Dimensions , Weight 5.5" x 9" x 10", 5 lbs

MCP300 - Termination Panel

Power requirement s 13.6 Vdc, limited to 100 mA. Power taken from radio power accessory connector.
TX Control Adjusts audio level to the radio microphone input.
RX Control Adjusts audio level to phone line. Adjustable from -20 dB to +5 dBm.
Intercom/Test butto n Used for test mode on power up, then for intercom.
Line balanc e Used to match the MCP300 to phone line.
Phone line impedanc e 600 ohms
Connections to phone lin e Two wires via modular jack.
Connections to radi o Supplied cable plugs into the power accessory connector of radio.
Connectio n to microphon e Palm and Desk mic jacks on front of MCP300, allows use of Midland palm desk mic.
Dimensions & Weigh t 1.6" x 5.5" x 5.5", 1.5 lbs



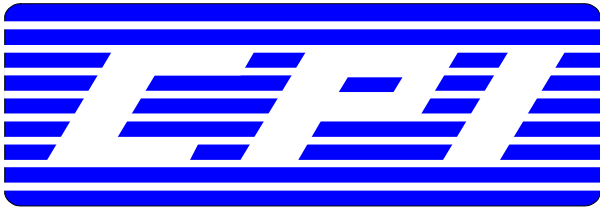

Multi Channel Products for Motorola CDM1550(LS) radios



MCR211A The MCR211A is a telephone style remote control unit designed for use with Motorola's CDM1550 and CDM1550LS radios. The remote has an LCD displays for channel and zone indications and 9 character alpha channel alias. The remote provides channel and zone up and down buttons, PTT indicator, on-hook PTT capability, monitor button and indicator, intercom button , scan button and indicator, privacy feature, and speaker volume control. The MCR211A allows incoming calls to be received through the speaker in the remote and transferred to the earpiece when the handset is removed from the cradle. Transmissions made from a remote are heard on all parallel remotes. The MCR211A allows for intercom capability between parallel remotes. The channel display and indicators on all remotes mirror that all other MCR211A remotes on the system. *NOTE:* When connected to the radio, the radio becomes dedicated to remote operation. You must use the MCP200C termination panel with this system.

MCP200C The MCP200C termination panel provides the interface between the CDM1550 radio and the MCR211A remotes. Installation of the termination panel requires tacking two wires (provided) from the adapter board to the front control head display board. The termination panel also includes a connector that is inserted in the accessory connector at the rear of the radio that allows the included RJ45 cable to plug into it and the front of the termination panel. The termination panel is housed in a rugged metal enclosure. The system can use any two wire or full duplex voice grade circuit between the radio and remote sites. Four wire/ full duplex is optional on this termination panel. When the termination panel is connected to the radio the radio becomes dedicated to remote operation.



MCR/MCP Series Specifications

MCR211 Alpha

Power Requirements	12 Vdc at 300 mA (alpha = 500 mA)
Indicators	Channel, Zone, PTT, Scan and Monitor, Privacy
Controls	Channel and Zone up & down, PTT, Scan, Monitor, Intercom, Privacy, and volume control.
Line input level	-20 dBm to +10 dBm
Line output level	-20 dBm to +10 dBm
Line impedance	200 K ohms on-hook / idle, 600 ohms off-hook / active
Receive compression	Less than 3 dBm change in output for 30 dBm change in input above thresh-hold.
Speaker output	2 watts (speaker mutes when hand-set off-hook)
Intercom	Front panel microphone and intercom switch or handset & intercom switch
Max. no. of parallel remotes	50
Connections	Modular jack for phone line and desk mic, 4 position modular jack for handset.
Dimensions, Weight	5.5" x 9" x 10", 5 lbs

MCP200C - Termination Panel

Power requirements	13.6 Vdc, limited to 100 mA. Power taken from radio microphone jack.
TX Control	Adjusts audio level to the radio microphone input.
RX Control	Adjusts audio level to phone line. Adjustable from -20 dBm to +10 dBm.
Intercom/Test button	Used for test mode on power up, then for intercom.
Line balance	Used to match the MCP200c to the phone line
Phone line impedance	600 ohms
Connections to phone line	Two wires via modular jack. Four wire/ Full Duplex interface optional.
Connections to radio	2 wires from adapter board to control head, rear accessory jack plug
Dimensions & Weight	1.6" x 5.5" x 5.5", 1.5 lbs.

Additional information on this system:

No programming software is necessary for the remote programming. Radio programming software is needed to change necessary parameters for use with this system. The channel and zone's of the radio must display "ch 00" and "z00" instead of alpha characters, so that the remotes will recognize the radio display.

Available options on this system include: MCR211A : WM - wall mount option, - BLK - unit black in color, DTMF or multi-format encoders; MCP200C -FD full duplex option.





DC Remotes

Model #	Description	List	Dealer
DR10	Telephone style DC remote with handset. Features off-hook monitor, front panel PTT, PTI circuit, line continuity sensing, cross mute, and 2 watt audio. Control currents are dip switch selectable. Jumper selectable trunking mode - status tones heard over handset earpiece. (Ash color)	\$284.50	\$185.00
DR20	Console style DC remote with desk microphone. Features panel mounted monitor and intercom, front panel PTT, PTI circuit, line continuity sensing, cross mute, and 2 watt audio. Control currents are dip switch selectable.	\$460.00	\$299.00
DR30	Console style DC remote with internal microphone. Features panel mounted monitor and intercom, front panel PTT, PTI circuit, line continuity sensing, cross mute, and 2 watt audio. Control currents are dip switch selectable.	\$268.25	\$175.00
DR40	Console style DC remote with goose neck microphone. Features panel mounted monitor and intercom, front panel PTT, PTI circuit, line continuity sensing, cross mute, and 2 watt audio. Control currents are dip switch selectable.	\$460.00	\$299.00

DC Remote Options

O = Cost Option S = Standard

Option	Description	DR10	DR20	DR30	DR40	List	Dealer
-M	Push button monitor - CTCSS disable	O	S	S	S	\$23.00	\$15.00
-I	Push button intercom	O	S	S	S	\$23.00	\$15.00
-2F	2 frequency selection - Control current is dip switch selectable	O	O	O	O	\$23.00	\$15.00
-FD	Full duplex operation on 4 wires - 4 wire operation is selectable	O	O	O	O	\$23.00	\$15.00
-DE	12 Key DTMF encoder	O	O	O	O	\$92.50	\$60.00
-UE1	12 Key multi-format encoder	O	O	O	O	\$169.25	\$110.00
-FS	Foot switch for PTT	O	O	O	O	\$69.25	\$45.00
-220V	220V AC wall pack transformer	O	O	O	O	\$23.00	\$15.00
-WM	Wall mount kit	O	O	O	O	\$23.00	\$15.00
-BLK	Unit color is black instead of ash	O	O	O	O	\$23.00	\$15.00
-L1/L2	Toggle switch to select between 1 of 2 base radios	O	O	O	O	\$30.00	\$20.00
-L1/L2/L3	Rotary switch allows user to select between 1 of 3 base radios	O	O	O	O	\$45.00	\$30.00
2 Line	2 line control with the ability to monitor both selected and un-selected base radio	O	O	O	O	\$110.00	\$75.00

DC Termination Panels

Model #	Description	List	Dealer
DTP1	Single frequency DC termination panel features audio amplification in both directions, dip switch selection of control currents, LED indication of panel status and on board squelch circuit. This unit will interface to virtually any two way radio. Board only - case option available.	\$125.50	\$81.50
DTP2	Same features as the DTP1 with monitor function.	\$150.50	\$97.50
DTP3	Same features as DTP2 with two frequency selection.	\$192.50	\$125.00
MR100	Single frequency plus monitor enclosed DC termination panel. Plugs directly into many Motorola mobile's microphone jack with no modifications. Uses +5.5mA PTT and -2.5 mA monitor. Features audio amplification in both directions. For Maxtrac 100, 300, Radius M10,100,120,M200, GM300, SM50, SM120, M1225, GTX, MCS2000, and CDM series radios.	\$230.75	\$149.95
JM100	Same features as the MR100 for use with the E.F. Johnson Challenger or 8600 series radio. +12mA PTT and +5.5mA monitor.	\$230.75	\$149.95

DC Termination Panels Options

Option	Description	List	Dealer
-C	Black, vinyl clad steel and aluminum enclosure for the DTP series panels	\$38.50	\$25.00
-4W/FD	Jumper selectable 4-wire (audio on first pair, control currents on second pair) or full duplex (RX audio on one pair, TX audio and control currents on second pair) DTP and XX100 series panels	\$23.00	\$15.00
-TR	Allows trunking status tones to pass back to remote earpiece when using the -10 series remote and the MR100 or JM100 panel. (Standard on DTP)	\$23.00	\$15.00
-80 cable	Cable to connect the DTP series to the Kenwood KCT19 connector on the -80 series radios	\$27.50	\$20.00
-90 cable	Cable to connect the DTP series to the Kenwood DB25 connector on the -90 series radios	\$27.50	\$20.00
-Moto cable	Cable to connect the DTP series to Motorola mobile radios with the 16 pin accessory connector	\$27.50	\$20.00
Rack/DTP	19 inch rack holds 4 DTP series panels - DTP must have case option	\$75.00	\$50.00
Rack/MR	19 inch single height rack holds 3 MR series panels	\$75.00	\$50.00

DC to Tone Converter

Model #	Description	List	Dealer
DTC1	DC to Tone control convertor box. Terminates one or more of your existing DC remotes and provides sequential tone control on a 600 ohm balanced pair. Features dip switch selection of desired DC control format with up to three functions. (F1/F2, PTT, and monitor)	\$397.00	\$258.00

Tone Remotes

Model #	Description	List	Dealer
TR10	EIA standard single frequency telephone style tone remote with handset. 1950 Hz function tone, 2050 Hz monitor, and 2175 Hz hold tone. Features on and off-hook monitor, front panel PTT, parallel transmit indication, cross mute, and 2 watt audio. PTI and x-mute are hardwire. (Ash color)	\$386.25	\$251.00
TR20	Console style desk microphone version of the TR10.	\$540.40	\$351.25
TR30	Console style internal mic version of the TR10.	\$386.25	\$251.00
TR40	Console style goose neck microphone version of the TR10.	\$540.50	\$351.25
TR10-4F	Telephone style remote with handset. E.I.A. standard 4 Frequency 1950-1650 Hz. function tones. 2050 Hz monitor and 2175 Hz hold tone. Features panel mounted monitor and intercom, front panel PTT, parallel transmit indication, cross mute, and 2 watt audio.	\$500.00	\$330.00
TR10-16F	Telephone style remote with handset. E.I.A. standard 4 Frequency 1950-450 Hz. function tones. 2050 Hz monitor and 2175 Hz hold tone. Features panel mounted monitor and intercom, front panel PTT, parallel transmit indication, cross mute, and 2 watt audio.	\$577.00	\$375.00
TR10-16F (-DM)	Desktop microphone replaces handset on multi-freq tone remote	\$72.50	\$50.00
(options) (-GM)	Gooseneck microphone replaces handset on multi-freq tone remote	\$95.00	\$65.00

Note: The TR series multi-frequency tone remotes are not “field programmable”. These units are factory set for the E.I.A. standard function, guard, and hold tones. If you require a “non standard” or special function tone set please contact CPI and we will be happy to assist you.

Tone Remote Options

O = Cost Option S = Standard

Option	Description	TR10-TR40	4-16F	List	Dealer
-2F	Two frequency selection	O	N/A	\$23.00	\$15.00
-4W	Four wire simplex	O	O	\$23.00	\$15.00
-BLK	Unit is black instead of ash	O	O	\$23.00	\$15.00
-FD	Full duplex operation on 4 wires. 4 wire operation is selectable.	O	O	\$61.50	\$40.00
-DE	12 Key DTMF encoder	O	O	\$92.50	\$60.00
-UE1	12 Key multi-format encoder	O	O	\$169.25	\$110.00
-FS	Foot switch for PTT	O	O	\$69.25	\$45.00
-220V	220V AC wall pack transformer	O	O	\$23.00	\$15.00
-WM	Wall mount kit	O	O	\$23.00	\$15.00

Tone Termination Panels

Model #	Description	List	Dealer
TTP1(N)	Single frequency plus monitor tone panel with jumper selectable 4W/FD operation, tone detection AGC, and LED indicators for panel status. 1950 Hz PTT and 2050 Hz monitor.	\$360.00	\$235.00
TTP2(N)	Two frequency version of the TTP1(N). F2 is 1850 Hz.	\$395.00	\$260.00
TTP216	Enclosed 16 frequency tone termination panel. 1950-450 Hz. User programmable function tones with 14 pre-sets. LED panel indicators, tone detection AGC, jumper selectable 2 wire, 4 wire, or full duplex operation. No programming cables needed with this unit. For use with radios that have channel select lines for BCD channel selection.	\$577.00	\$375.00
MR200(N)	Enclosed version of the TTP1(N) plugs directly into the microphone jack on certain radios. For Maxtrac 100,300, Radius M10,100,120,M200, GM300, SM50, SM120, M1225, GTX, MCS2000, and CDM series radios	\$465.00	\$305.00
MR202(N)	Two frequency version of the MR200(N). Requires a radio jumper for channel selection operation.	\$538.50	\$349.95
JM200(N)	Modified version of the MR200(N) for the E.F. Johnson Challenger or 8600 series radios.	\$465.00	\$305.00

Tone Termination Panel Options

Option	Description	List	Dealer
-C/TTP(N)	Black, vinyl clad steel and aluminum enclosure for the TTP(N) series panels	\$43.00	\$30.00
Rack/(N)	19" single height rack holds 3 of the above panels - Must have case option	\$75.00	\$50.00
-80 cable	Cable to connect the TTP or TTP(N) series to a Kenwood KCT19 connector on the -80 series radios	\$27.50	\$20.00
-90 cable	Cable to connect the TTP or TTP(N) series to the DB25 connector on the Kenwood -90 series radios	\$27.50	\$20.00
Cable 216-90	Cable to connect the TTP216 series to the DB25 connector on the Kenwood -90 series radios	\$27.50	\$20.00
-moto cable	Cable to connect the TTP, TTP(N) or TTP216 series to Motorola mobile radio that uses the 16 pin accessory connector.	\$27.50	\$20.00

Model #	Description	List	Dealer
TTP1	Single frequency plus monitor tone panel. EIA standard 1950 Hz PTT, 2050 Hz monitor. Case option is optional.	\$333.00	\$216.50
TTP2	Same as TTP1 with 2 frequency control. F2 is 1850 Hz.	\$378.50	\$246.00
TTP4	Enclosed 4 frequency tone panel. 1950, 1850, 1750, 1650 Hz PTT and 2050 Hz monitor. Relay output is jumper selectable for momentary or latched operation.	\$553.75	\$360.00
TTP10	Same as TTP4 with 10 relay outputs. 1950-1050 Hz PTT and 2050 monitor.	\$709.75	\$467.25

Model # Description

TTPBCD	BCD relay output panel is capable of 10 channel selection . 1950-1050 Hz PTT and 2050 Hz monitor	\$607.75	\$395.00
MR200	Single frequency plus monitor enclosed tone panel plugs directly into the microphone jack on certain radios. For Maxtrac 100,300, Radius M10,100,120,M200, GM300, SM50, SM120, M1225, GTX, MCS2000, and CDM series radios	\$461.50	\$299.95
JM200	Same features as the MR200 for use with the E.F. Johnson Challenger or 8600 series radio.	\$461.50	\$299.95

Option	Description	List	Dealer
-4W/FD	Jumper selectable -4W/FD for TTP1, TTP2, TTPXX, and MR series.	\$23.00	\$15.00
-C/TTP	Case option for the TTP1 and TTP2.	\$38.50	\$25.00
Rack/TTP	Single height 19" rack holds 4 TTP1 or TTP2 panels. Must have case opt.	\$75.00	\$50.00

See tone panel options on page 4 for cable and rackmount options

Local Extension Remotes

Model #	Description	List	Dealer
LE10	Telephone style local extension with handset. Features off-hook monitor, front panel PTT, PTI circuit and 1 watt audio.	\$215.50	\$140.00
LE20	Console style local extension with desk microphone. Features panel mounted monitor and intercom, front panel PTT, PTI circuit, and 1 watt audio.	\$361.50	\$235.00
LE30	Console style local extension with internal microphone. Features panel mounted monitor and intercom, front panel PTT, PTI circuit, and 1 watt audio.	\$215.50	\$140.00
LE40	Console style local extension with goose neck microphone. Features panel mounted monitor and intercom, front panel PTT, PTI circuit, and 1 watt audio.	\$361.50	\$235.00

Local Extensions Options

O = Cost Option S = Standard

Option	Description	LE10	LE20	LE30	LE40	List	Dealer
-M	Push button monitor. CTCSS disable	O	S	S	S	\$23.00	\$15.00
-I	Push button intercom.	O	S	S	S	\$23.00	\$15.00
-2F	2 frequency selection.	O	O	O	O	\$23.00	\$15.00
-WP	Wall plug-in power transformer	O	O	O	O	\$23.00	\$15.00
-DE	12 Key DTMF encoder	O	O	O	O	\$92.50	\$60.00
-UE1	12 Key multi-format encoder	O	O	O	O	\$169.25	\$110.00
-FS	Foot switch for PTT	O	O	O	O	\$69.25	\$45.00
-220V	220V AC wall pack transformer	O	O	O	O	\$23.00	\$15.00
-WM	Wall mount kit	O	O	O	O	\$23.00	\$15.00
-BLK	Unit color is black	O	O	O	O	\$23.00	\$15.00
LE cable	7 conductor cable - per foot					\$.60	\$.30

Specialty Remote Systems for Kenwood mobile radios

Model #	Description (90 series mobiles)	List	Dealer
MCR411A	Telephone style remote with handset for -90 series Kenwood radios. Provides Group/Channel display with a user programmable 9 character alpha numeric channel identifier, remote Group/Channel change, scan, monitor, front panel PTT, intercom, and privacy.	\$692.25	\$450.00
MCR411A-DM	Console version of the MCR411A with desk microphone.	\$720.00	\$500.00
MCP401	Termination panel interfaces the MCR411 series remotes to the Kenwood -90 series radio through the DB25 connector. Requires programming of accessory pins on the DB25 connector.	\$461.50	\$299.95

Model #	Description (80 series mobiles)	List	Dealer
TSR412A	Telephone style remote with handset for the -80 series Kenwood radios. Provides System/Group display with a user programmable 9 character alpha numeric identifier, remote System/Group change, scan, monitor, front panel PTT, intercom, and privacy.	\$692.25	\$450.00
TSR412A-DM	Console version of the TSR412A with desk microphone.	\$720.00	\$500.00
TSP402	Termination panel interfaces the TSR412A series remotes to the -80 series Kenwood radios. Uses the Kenwood KCT-19 connector. Requires radio programming changes to be made.	\$461.50	\$299.95

Model #	Description (30 series mobiles)	List	Dealer
MCR410A	Telephone style remote with handset for -30 series Kenwood radios. Provides Channel display with a user programmable 10 character alpha numeric channel identifier, remote channel change, scan, monitor, front panel PTT, intercom, and privacy	\$692.25	\$450.00
MCR410A-DM	Console version of the MCR410A with desk microphone	\$720.00	\$500.00
MCR410	Telephone style remote with handset for -30 series Kenwood radios. Provides LED channel display, remote channel change, scan, monitor, front panel PTT, and intercom.	\$577.00	\$375.00
MCR420	Console style remote with desk microphone for -30 series Kenwood radios. Provides LED channel display with channel change, scan, monitor, front panel PTT, and intercom.	\$692.25	\$450.00
MCP400	Termination panel and adapter for Kenwood 630, 730, and 830 series.	\$500.00	\$325.00

Model #	Description (40 series mobiles)	List	Dealer
TSR411A	Telephone style remote with handset for the -40 series Kenwood radios. Provides System/Group display with a user programmable 9 character alpha numeric identifier, remote System/Group change, scan, monitor, front panel PTT, intercom, and privacy	\$692.25	\$450.00
TSR411A-DM	Console version of the TSR411A with desk microphone	\$720.00	\$500.00
TSP401	Termination panel connects TSR411 series to the -40 series Kenwood radios. Uses the Kenwood KCT-19 connector	\$461.50	\$299.95

FOR SPECIALTY REMOTE OPTIONS SEE PAGE 9 OF THIS PRICE GUIDE

The following multi-channel remotes for the various Motorola models can be used together in a single system. Alpha and non alpha remotes will function together in the same system using 2 wire operation. Only the alpha remotes and termination panels are capable of full duplex operation. Non alpha remotes can not be used in a full duplex system.

Model #	Description	List	Dealer
MCR210A	Telephone style remote with handset. Provides channel display with a user programmable 10 character alpha numeric channel identifier, remote channel change, scan, monitor, front panel PTT	\$692.25	\$450.00
MCR210A-DM	Console version of the MCR210A with desk microphpne.	\$720.00	\$500.00
MCR210	Telephone style remote with handset provides LED channel display. Provides remote control of channel change, scan, and monitor. Unit also has front panel PTT and intercom features.	\$577.00	\$375.00
MCR220	Console style version of the MCR210 with desk microphone.	\$692.25	\$450.00
MCR250	19 inch rack mount vesion of the MCR210 with internal microphone.	\$923.00	\$600.00

Model #	Description	List	Dealer
MCP200	Termination panel and adapter interfaces the MCR200 series remotes to the Motorola Maxtrac 300 and radius M200 radios.	\$461.50	\$299.95
MCP200G	Termination panel and adapter interfaces the MCR200 series remotes to the Motorola Radius GM300 radio.	\$461.50	\$299.95
MCP200M	Termination panel and adapter interfaces the MCR200 series remotes to the Motorola Radius M1225 20 channel radio. (Radio is dedicated to remote operation in this system.)	\$461.50	\$299.95
MCP200MLS	Termination panel and adapter interfaces the MCR200 series remotes to the Motorola Radius M1225(LS) radio. (Radio is dedicated to remote operation in this system.)	\$461.50	\$299.95
MCP200S	Termination panel and adapter interfaces the MCR200 series remotes to the Motorola Radius SM120 radio.	\$461.50	\$299.95

Model #	Description (CDM1550 and CDM1550LS)	List	Dealer
MCR211A	Telephone style remote with handset. Provides channel display with a user programmable 9 character alpha numeric channel and zone identifier, remote channel change, scan, monitor, front panel PTT. For use on Motorola CDM1550 series radios.	\$692.25	\$450.00
MCR211A-DM	Console version of the MCR210A with desk microphpne.	\$720.00	\$500.00
MCP200C(LS)	Termination panel for connecting the MCR211A remotes to the CDM1550 and CDM1550(LS) radios.	\$461.50	\$299.95

FOR SPECIALTY REMOTE OPTIONS SEE PAGE 9 OF THIS PRICE GUIDE

Model #	Description (Maxtrac 800 and 900 Mhz)	List	Dealer
TSR210A	Telephone style remote with alpha numeric display features a 10 character user programmable channel identifier. Features system and group selection, scan and monitor functions, front panel PTT, and intercom between parallel remotes. Dip switch selectable FD operation.	\$692.25	\$450.00
TSR210A-DM	Console style TSR210A with desk microphone.	\$720.00	\$500.00
TSR200	Telephone style remote with handset. Features system and group selection, scan and monitor functions, front panel PTT, and intercom between parallel remotes. Channel indication is by LED display.	\$577.00	\$375.00
TSP200	Termination panel and adapter board connects the TSR200 series to the Motorola Maxtrac 800Mhz B7 radio.	\$461.50	\$299.95
TSP209	Termination panel and adapter board connects the TSR200 series to the Motorola Maxtrac 900Mhz B7 radio.	\$499.00	\$324.50

Model #	Description (Syntech XTR radios)	List	Dealer
MCR310A	Telephone style remote with alpha numeric display features a 10 character user programmable channel identifier. Provides channel selection, scan and monitor functions, front panel PTT, and intercom between parallel remotes. Dip switch selectable FD operation	\$692.25	\$450.00
MCR310A-DM	Console style MCR310A with desk microphone.	\$720.00	\$500.00
MCR310	Telephone style remote with handset. Provides channel selection, scan and monitor functions, front panel PTT, and intercom between parallel remotes. Channel indication is by LED display.	\$577.00	\$375.00
MCR320	Console style version of MCR310 with desk microphone. Provides channel selection, scan and monitor functions, front panel PTT, and intercom between parallel remotes.	\$692.25	\$450.00
MCP300	Termination panel and adapter connects the MCR300 series remotes to the Midland Syntech XTR radio.	\$500.00	\$325.00

Model #	Description (Johnson 8600 series)	List	Dealer
TSR110A	Telephone style remote with handset. Provides alpha numeric display of System/Group and 10 character user programmable channel identifier. Provides control of system, group, scan and aux. functions.	\$615.25	\$399.95
TSP101	Termination panel for use with the TSR110 on E.F .Johnson 8605, 8610, 8615, and 8655 radios	\$461.50	\$299.95

FOR SPECIALTY REMOTE OPTIONS SEE PAGE 9 OF THIS PRICE GUIDE

Options for Specialty Remotes

Option	Description	List	Dealer
-DE	12 key DTMF encoder	\$92.50	\$60.00
-UE1	Panel mounted 12 key multi-format encoder for non MCRX20 models.	\$169.25	\$110.00
-UE1P	Panel mounted 12 key multi-format encoder for MCRX20 models.	\$215.25	\$140.00
-D	Allows the use of the MCP200 or TSP200 on the Desktrac.	\$23.00	\$15.00
-4W/FD	Four wire / full duplex option for MCP/TSP termination panel. Not compatible with non-alpha MCR or TSR remotes. Not available on TSP101.	\$23.00	\$15.00

Satellite Products

Model #	Description (Mitsubishi and Westinghouse Satellite)	List	Dealer
RST100 RST200	Telephone style remote with handset for use with the Mitsubishi ST1XX (RST100) or Westinghouse 1000 (RST200) dispatch service. Each unit has audio and visual indications of system status. Unit provides PTT, privacy, and intercom between parallel remotes. Must be used with the appropriate PST termination panel.	\$615.50	\$400.00
PST100 PST200	Termination panel to connect the RST series remotes to the Mitsubishi (PST100) or Westinghouse (PST200) satellite transceivers.	\$461.50	\$299.95
SV100 SV200	Controller used to form an in-vehicle repeater when used with a Mitsubishi STX11 (SV100) or Westinghouse 1000 (SV200) satellite radio and a mobile two-way radio. Standard connector provided is for use with Motorola mobiles that use the standard 16 pin accessory connector but will work with most mobile radios. Call for applications.	\$550.00	\$358.00

Special Application units

DTP-RAY	Full duplex termination panel board that provides 600 ohm balanced audio with amplification in both directions.	\$150.00	\$100.00
Decoders	Decoders are available as an option on many remotes. CPI will factory install these as an alert feature or as a "HEAR" system. Audio is muted until the specified tone is decoded.	Contact CPI	
GE DC format	DC remotes can be special ordered to work with the older GE format.	Contact CPI	
Specials	Please contact CPI for any information on any special requirements that you may have. We will be happy to assist you.	Contact CPI	

RETURN POLICY

All returns must be made within 30 days of invoice date, after 30 days all sales are final. Sales of special orders or custom units are final on date of sale. Returns that are unopened will be subject to a restocking fee equal to 20% of the invoice price. Returns that have been opened will be subject to an additional testing or refurbishing fee. If the returned item shows a defect that is not covered under warranty, you will be charged normal rates for repair. All returns will be for credit only unless prior arrangements have been made with CPI. All returns must have a RMA number clearly marked on the shipping label. To obtain an authorization number contact CPI at 800-869-9128.

TERMS

All dealers will be requested to complete a credit application. (Texas accounts will require a Tax I.D. number to be furnished). After review, dealer accounts will be placed on one of the following credit or purchase plans:

1. Net 30 day terms up to your credit limit.
2. COD/ Company check accepted.
3. COD-Cash
4. Bank wire or certified funds in advance.

INTERNATIONAL TERMS

Terms for all international shipments are prepayment by bank wire transfer. The full amount of the order, plus any applicable bank and shipping charges must be received before any order is shipped. Orders can be shipped freight collect or pre-paid by UPS, Federal Express, or the freight forwarder of your choice. All bank and shipping information will be sent to the customer upon receipt of order. If you have any questions or need information please contact us.

PRODUCT WARRANTY

CPI Communications, Inc. warrants each product manufactured by it to be free from defective material and workmanship and agrees to remedy any such defects or to furnish a new part in exchange for any part of any unit of its manufacture which under normal installation use or service discloses such defects, provided the unit is delivered by the customer to our authorized service center intact within 2 years or purchase. No credit will be given for unauthorized repairs.

This warranty does not extend to any product that has been subject to misuse, neglect, accident, incorrect wiring not our own, improper installation, nor units which have been altered or repaired outside of our service center.

This warranty is in lieu of all other warranties expressed or implied and no person is authorized to assume for us any other liability in connection with the sale of our products.

Please note: CPI products are not authorized for use in applications where nonperformance may be life threatening, or where substantial risk to life and property may be present, without express written consent of the president of CPI Communications, Inc. CPI Communications, Inc. shall never be held liable for consequential or indirect damages.



Communications, Inc

941 Hensley Lane Wylie, TX 75098 Phone (972)429-7160 (800)869-9128
Fax (972)429-7165 (888)437-5360 www.cpicomm.com